

1

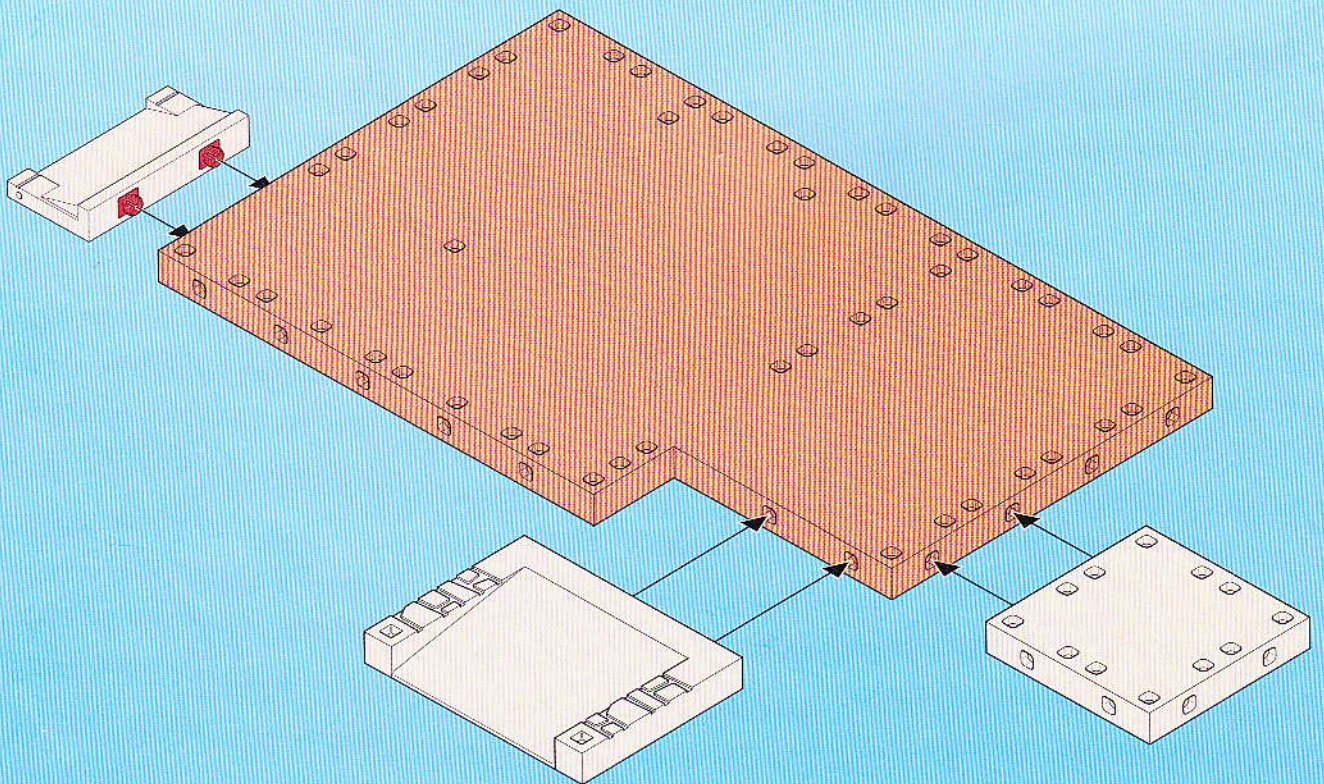

2

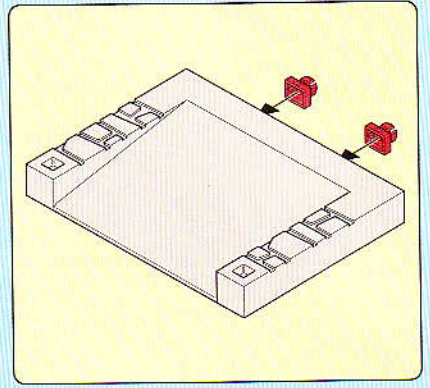
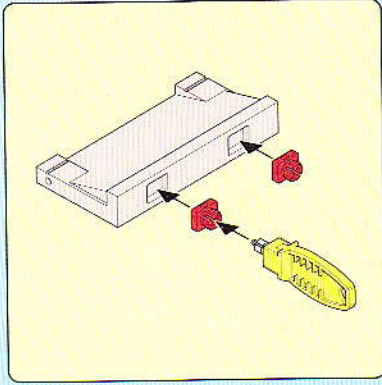
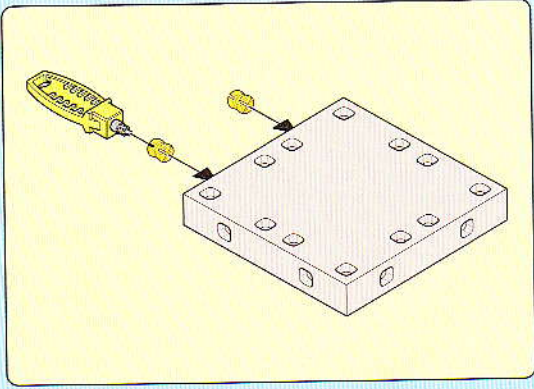
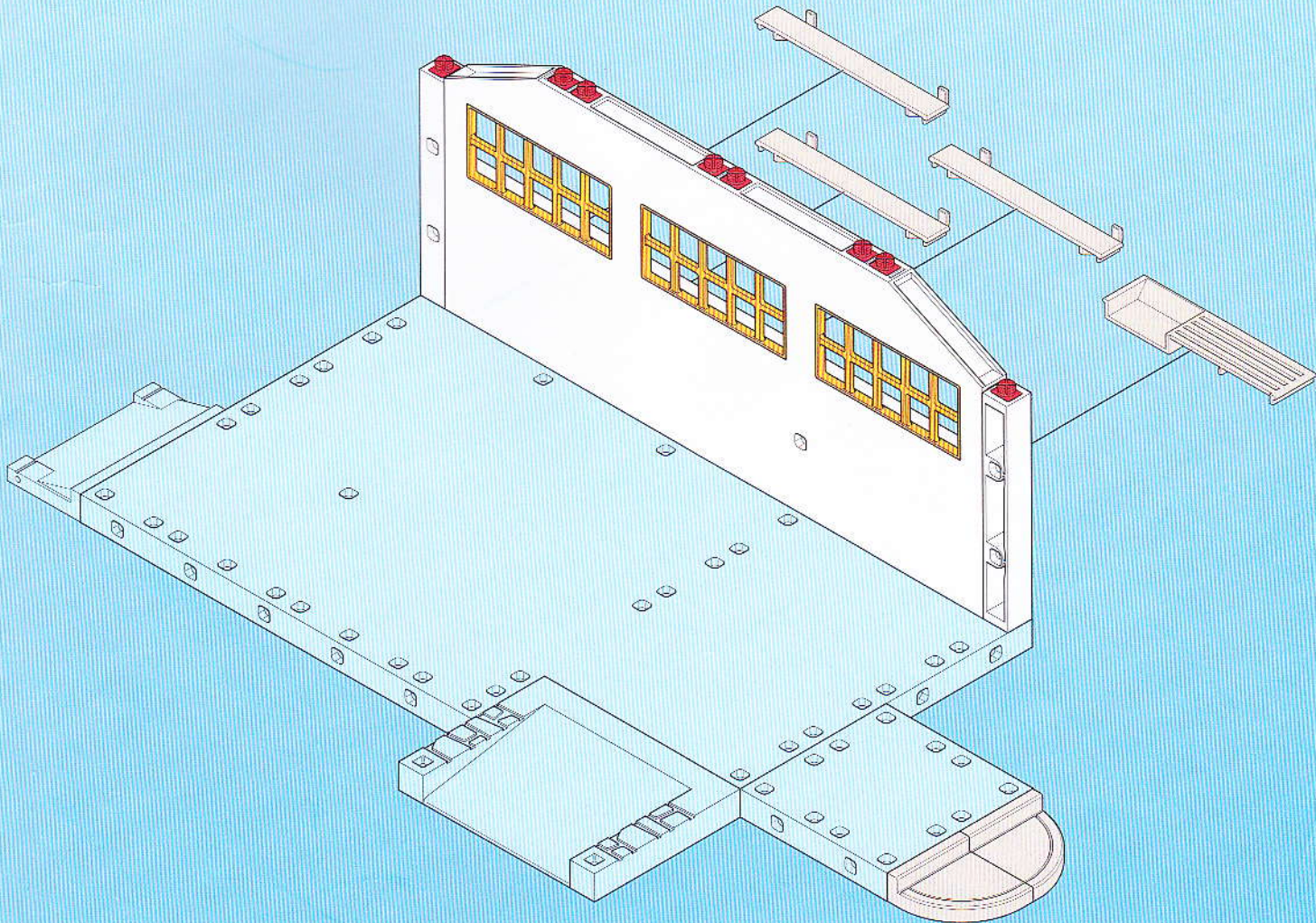
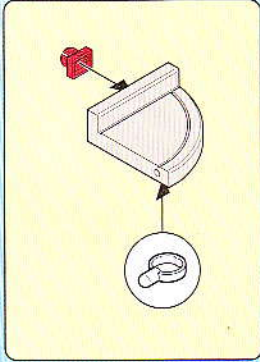
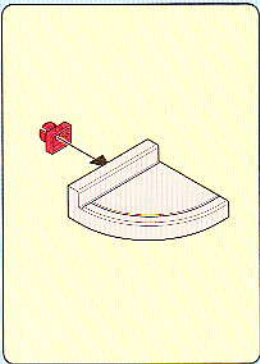
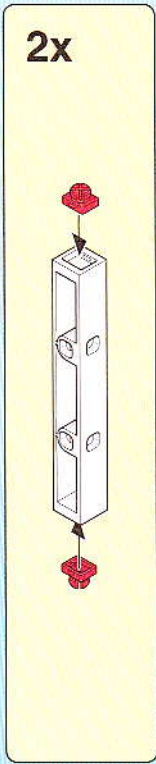
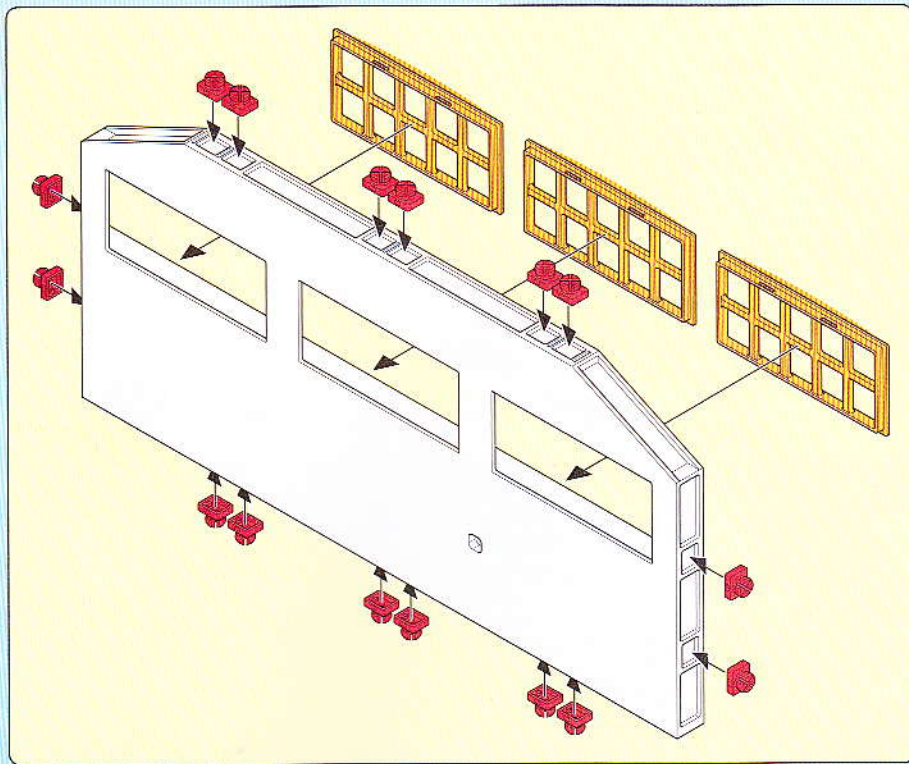

3

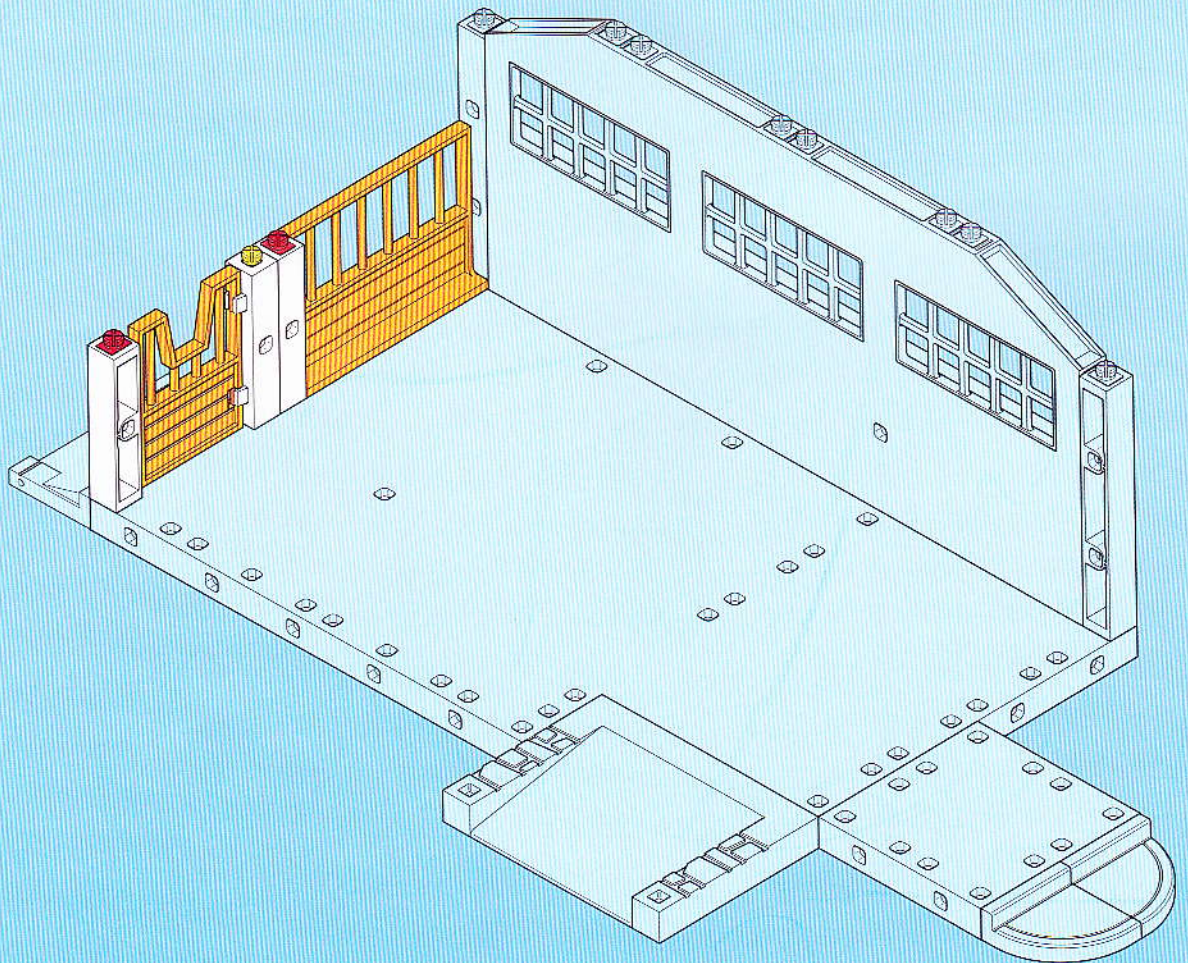
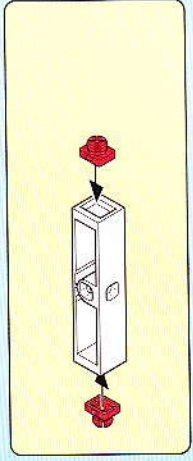
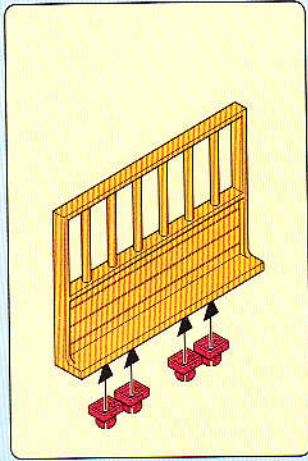
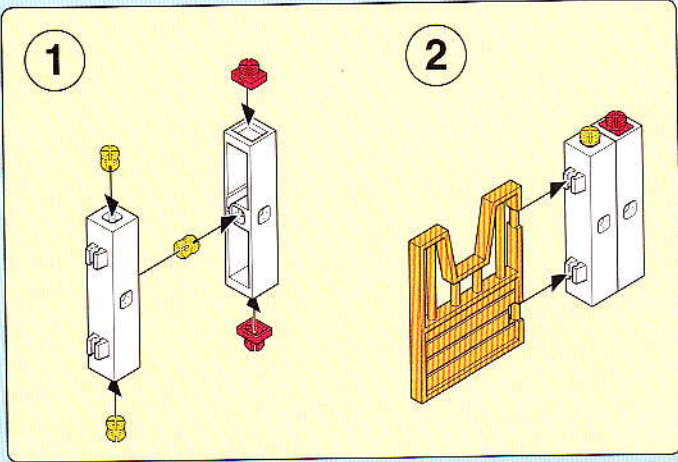

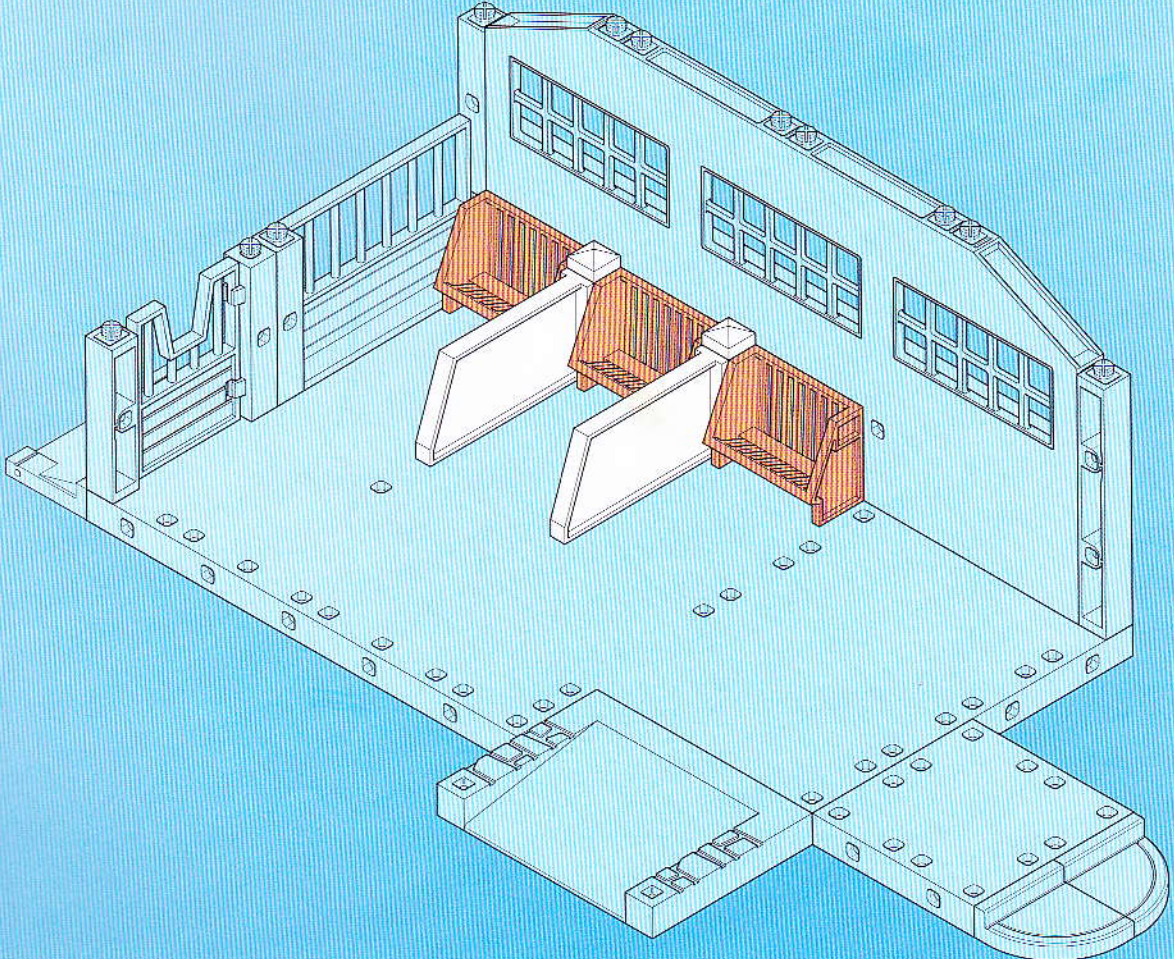
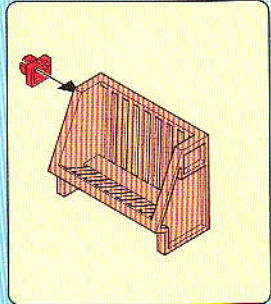
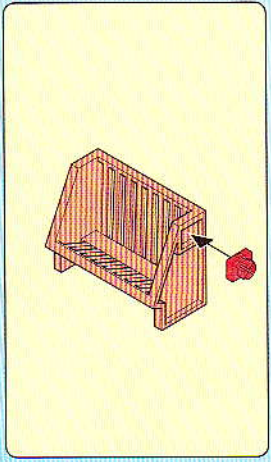
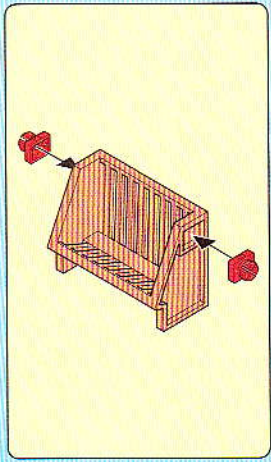
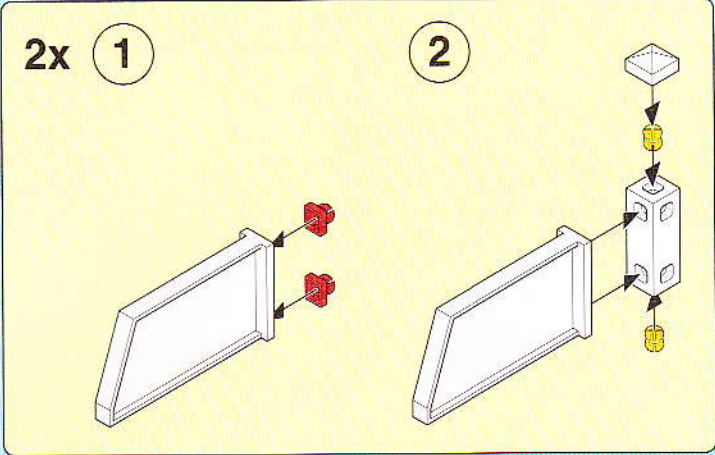

5

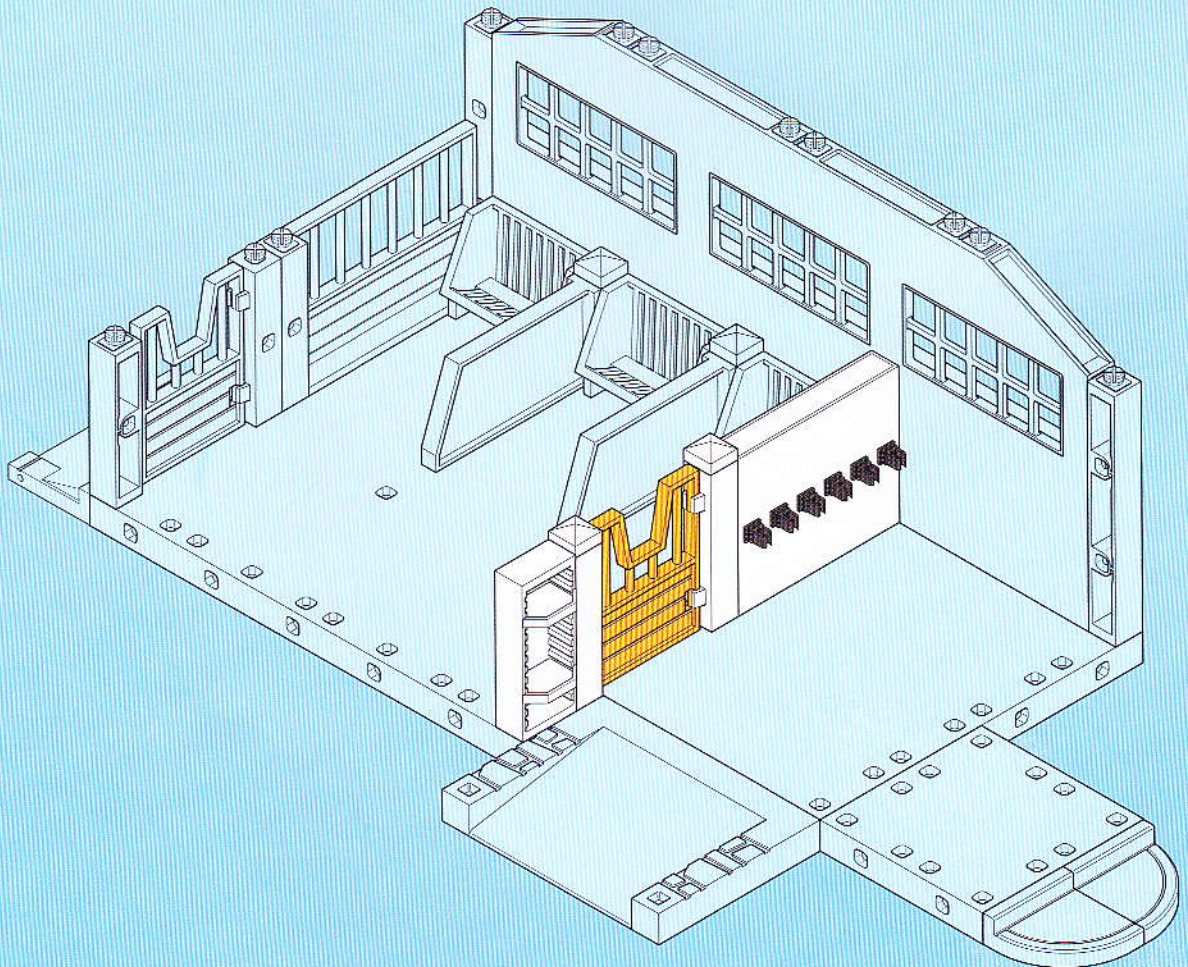
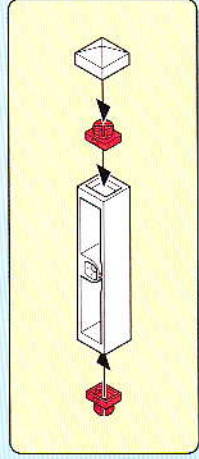
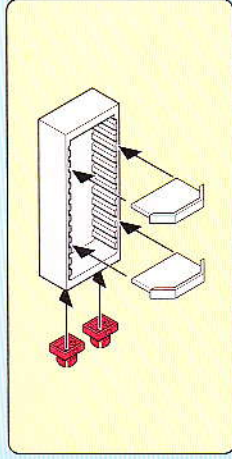
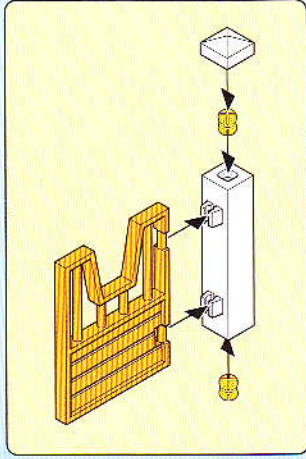
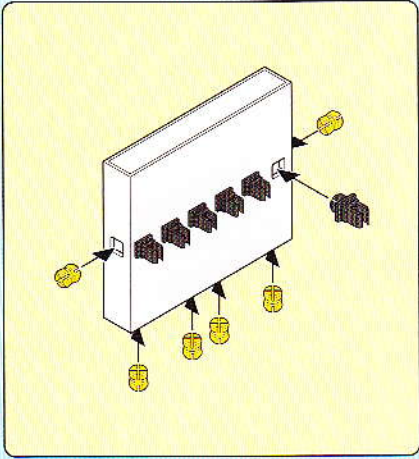

1 3x

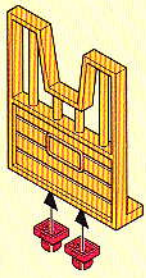

2

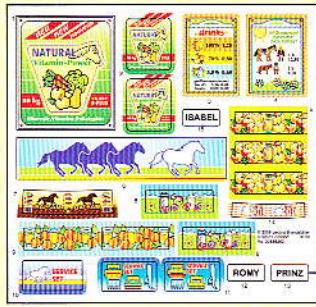

13

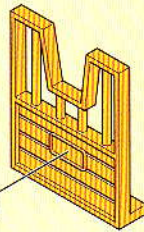

12

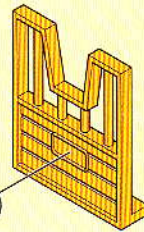

15

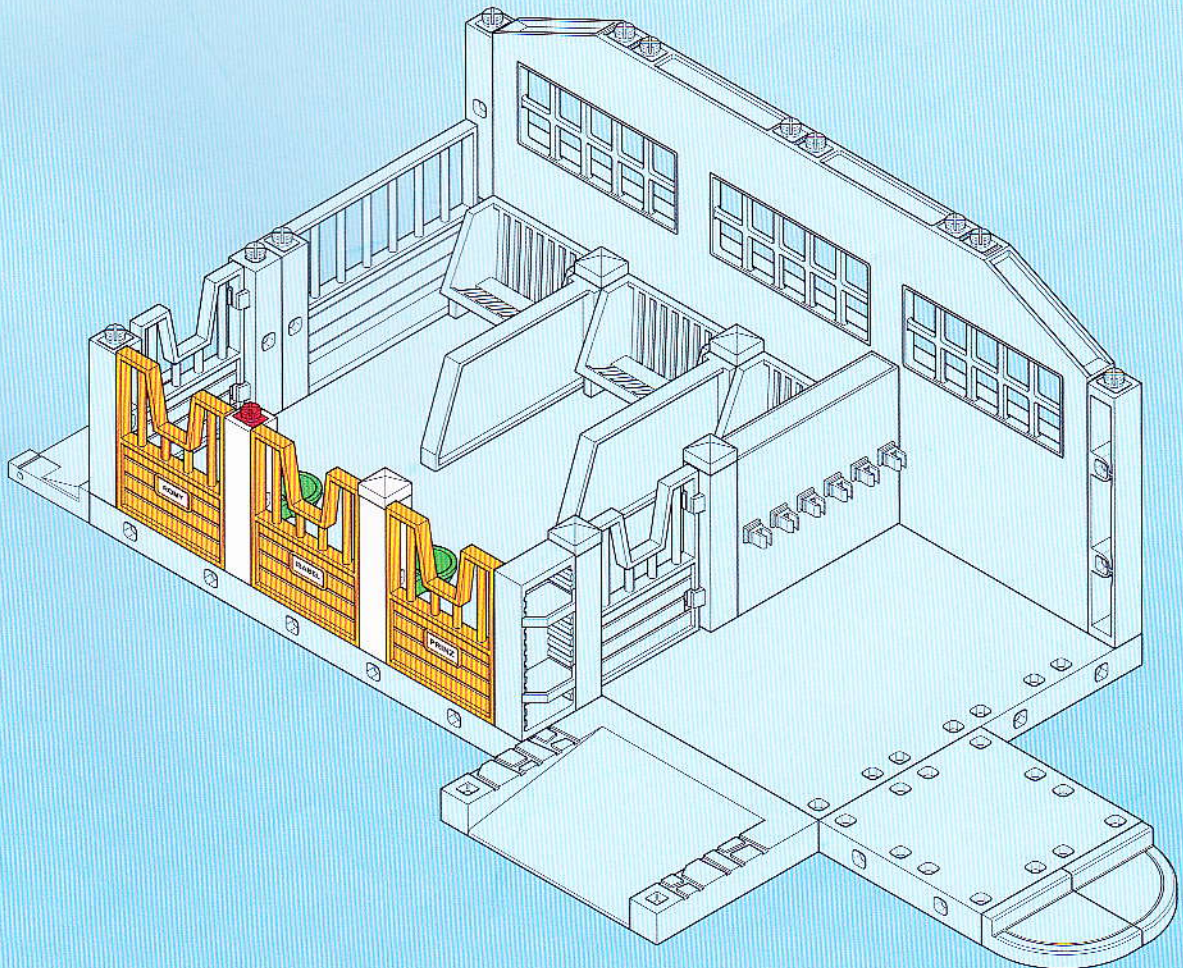
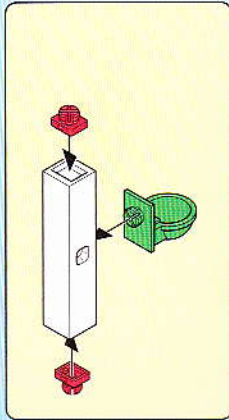
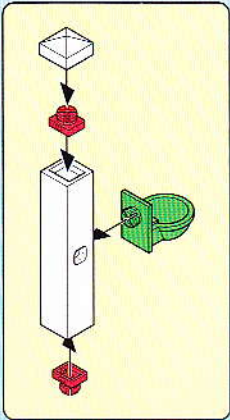
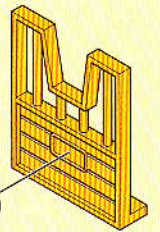



8

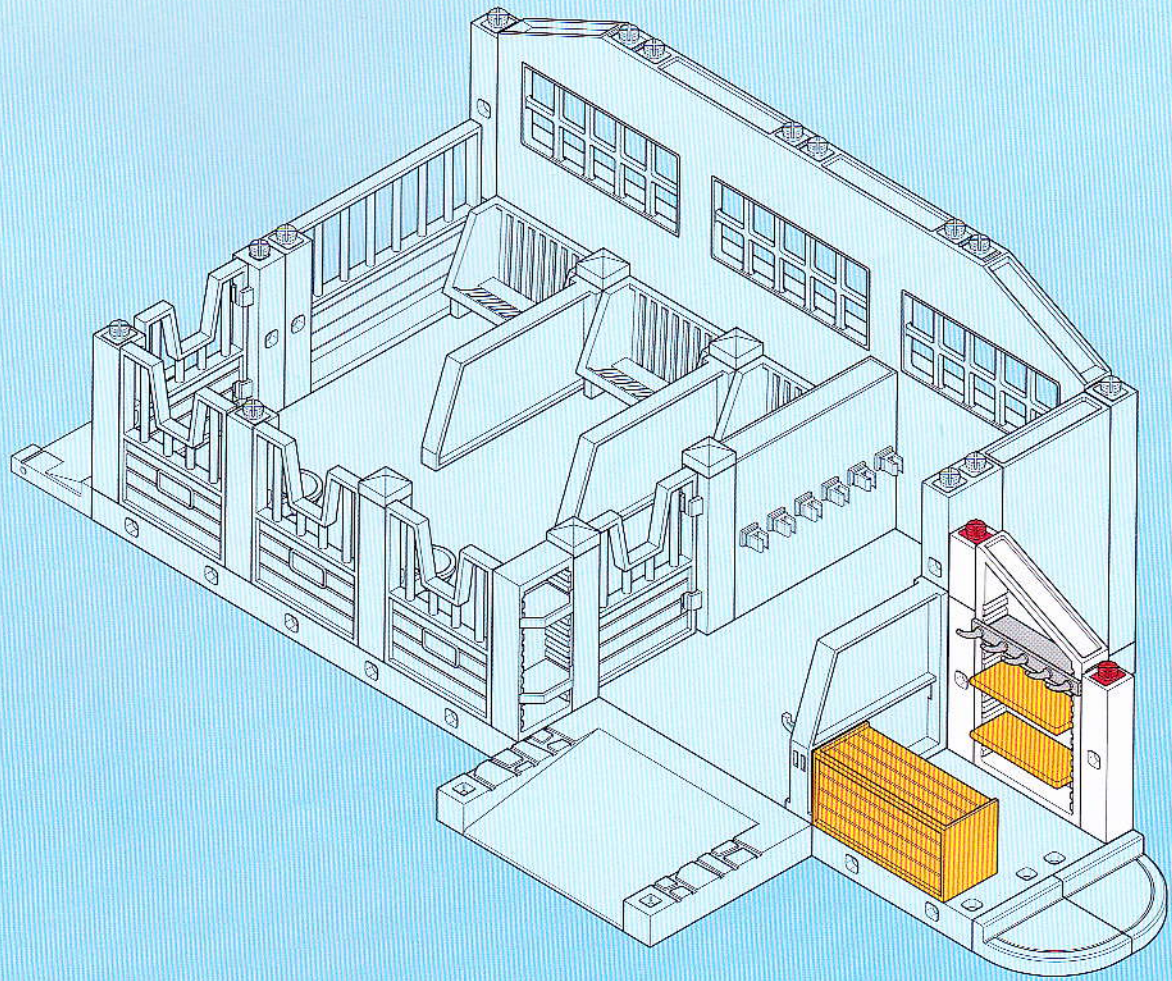
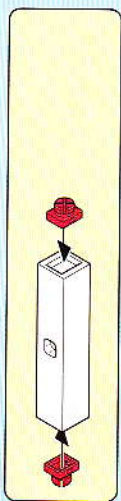
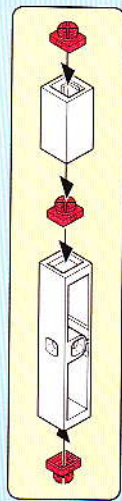
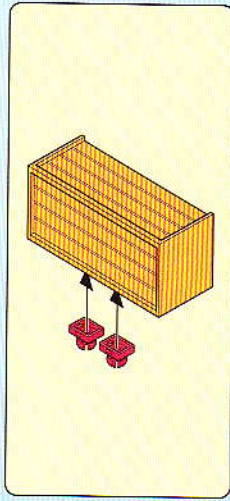
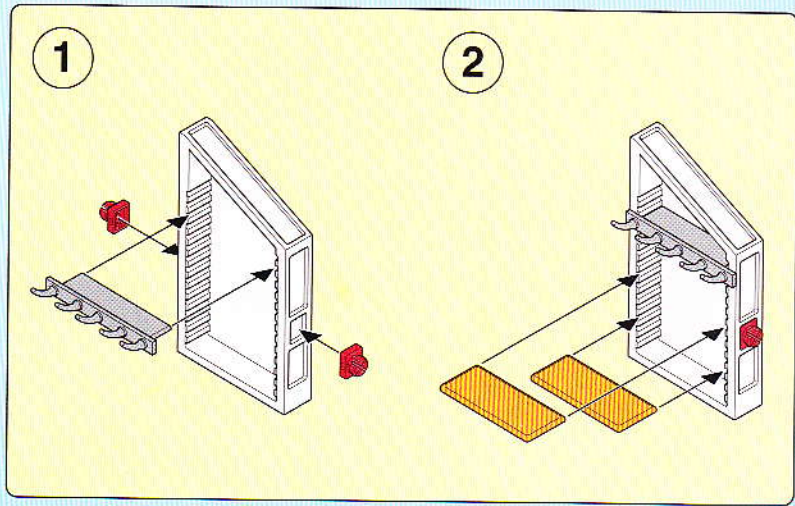



9

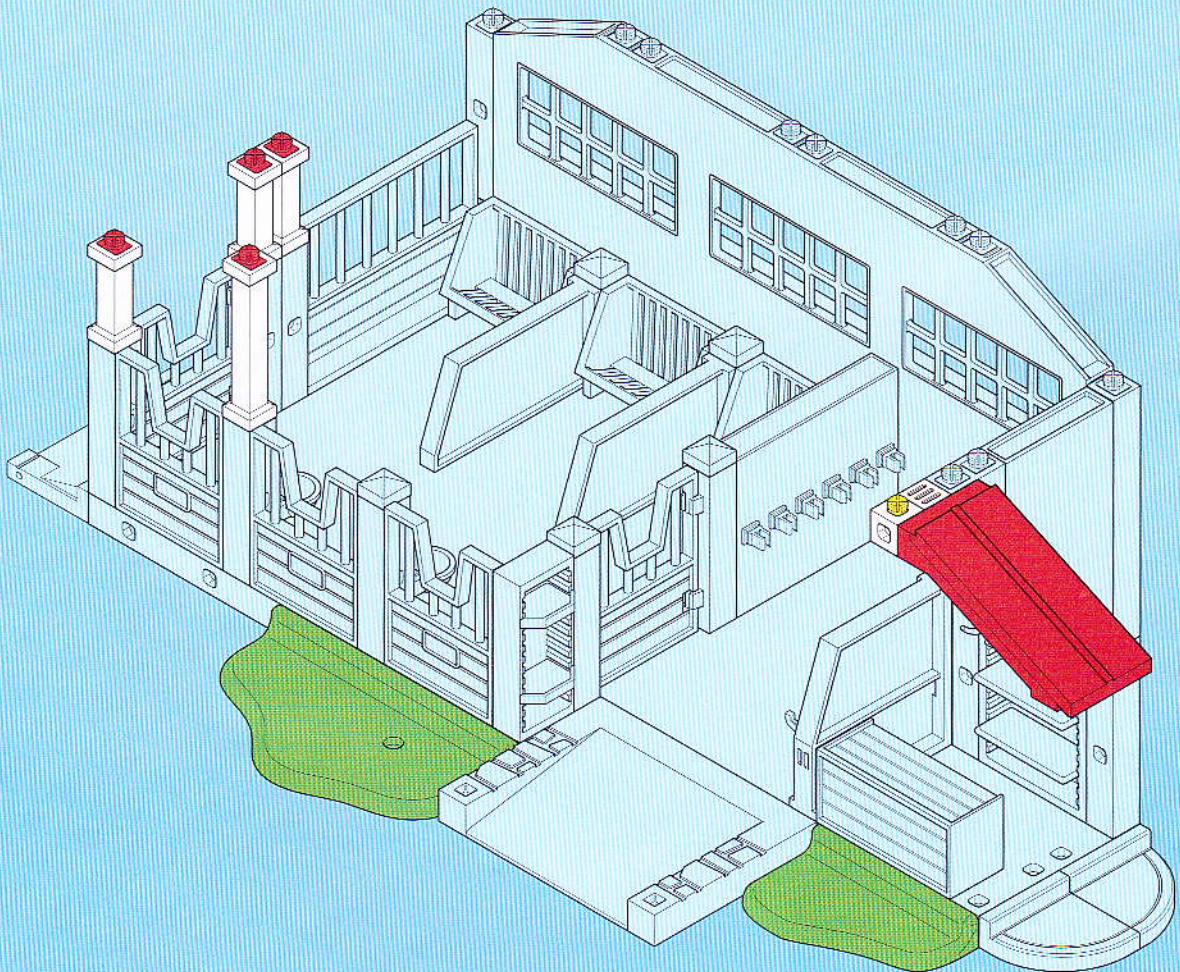
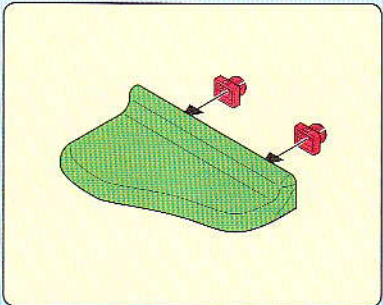
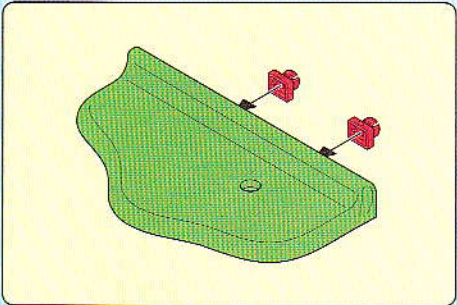
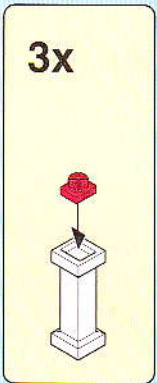
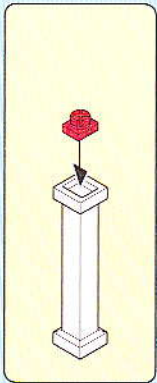
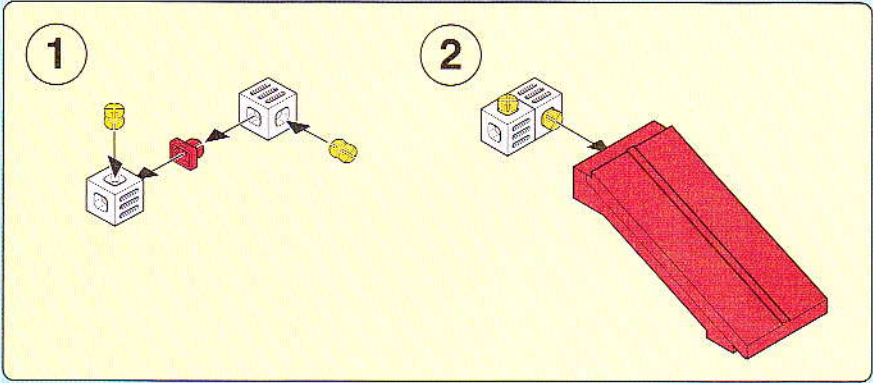

10

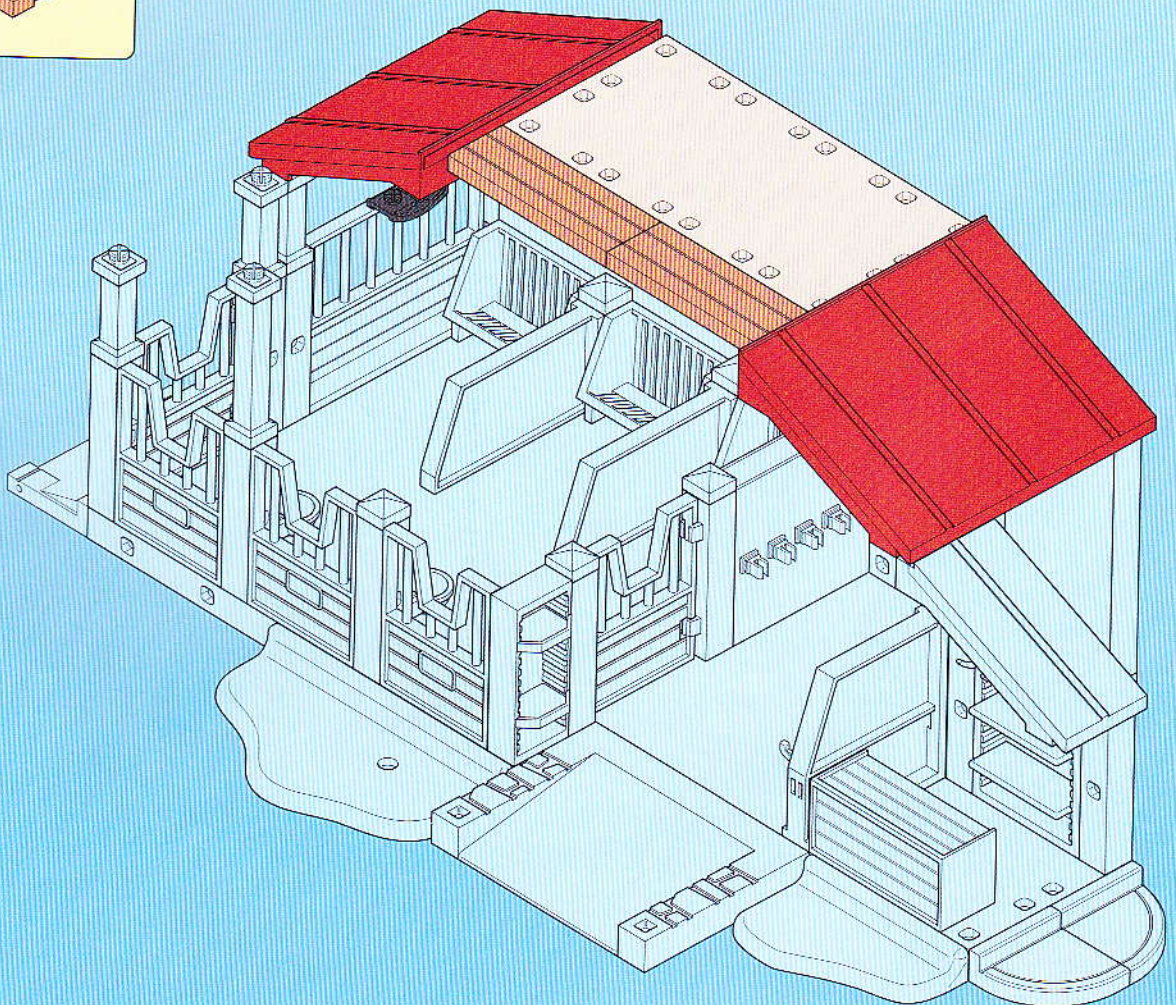
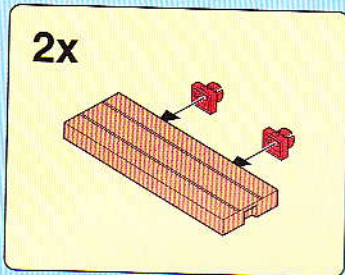
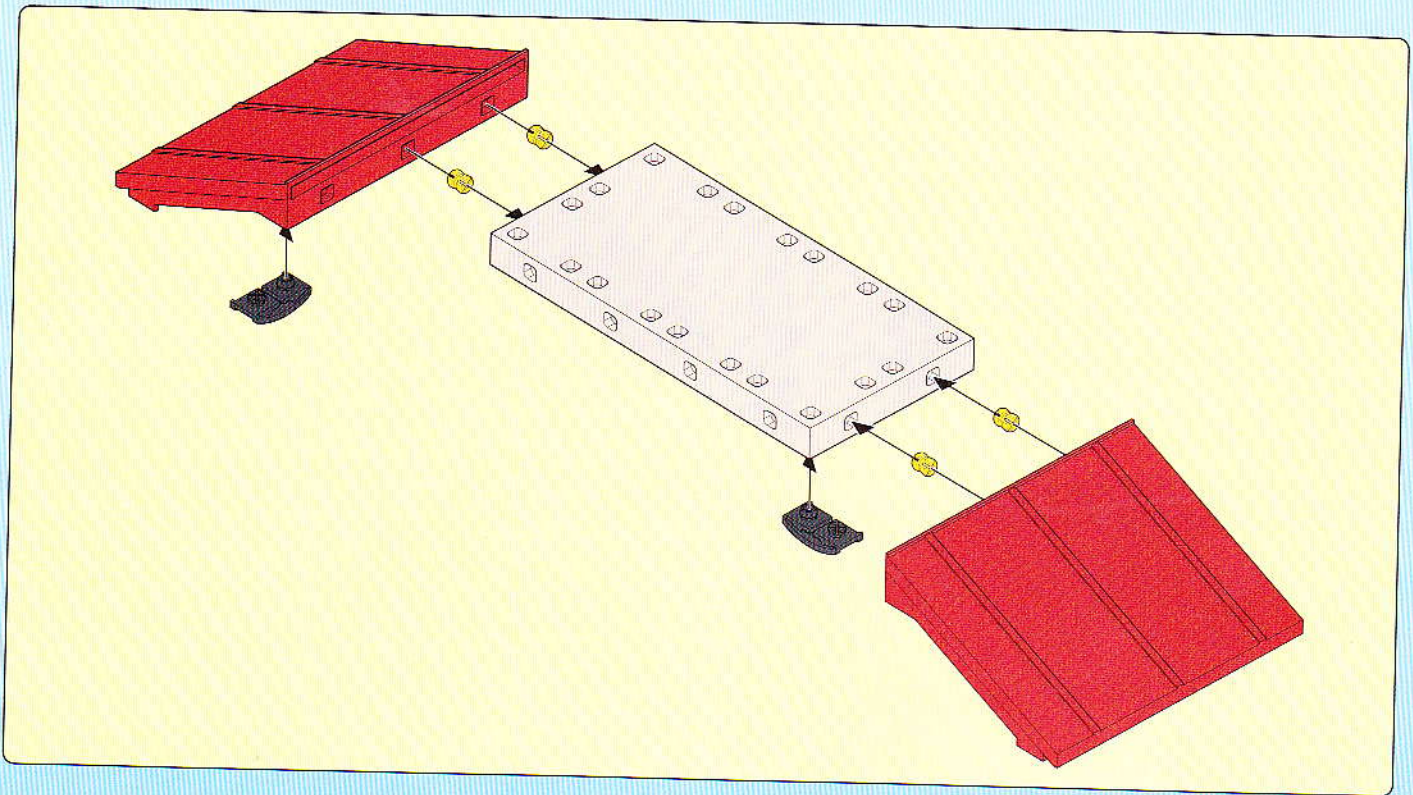



12

